

*We exist to provide outstanding opportunities through recreation for children and adults with disabilities.*

February 21, 2017

To Whom It May Concern,

Thank you for your interest in the Northwest Special Recreation Association (NWSRA) bid for furniture and installation.

Items outlined in this bid will be used to furnish an adult day program for individuals with disabilities, this program will be opening in May. Completed bids should include the following forms:

- Furniture and Installation Bid Proposal Worksheet
- Furniture and Installation Bid Proposal Form
- Furniture and Installation Bid Proposal Timeline Acknowledgement
- List of References

If interested in submitting a bid, please have the proper officer of your firm enter the proposed bid information on the above stated sheets. All forms should be signed in ink, placed in sealed envelope marked "Furniture and Installation Quote" and submitted no later than Wednesday, March 8 at 3:00 p.m. to Andrea Griffin, Northwest Special Recreation Association 3000 W. Central Rd., Suite 205, Rolling Meadows, IL 60008. The bids will be opened on Wednesday, March 8 at 3:00 p.m. at the address stated above. You are welcome to, but are not required to attend the bid opening.

If you have questions regarding the bid, please submit all questions by Wednesday, March 1 via e-mail to [agriffin@nwsra.org](mailto:agriffin@nwsra.org). All questions will be compiled, and all bidders will receive an e-mail with answers by Friday, March 3. No additional questions regarding the bid will be answered beyond this time frame.

References will be checked and a decision as to who will receive the bid will be made at the NWSRA Board Meeting on Wednesday, March 22<sup>nd</sup>, 2017 at 10:30 a.m. The company receiving the bid will be contacted by phone following the board meeting. Others will be sent a letter by Friday, March 24, 2017.

Thank you for your consideration.

Sincerely,

Andrea Griffin, CTRS, CPRP  
Superintendent of Recreation

*An extension of the local park districts serving*

Arlington Heights • Bartlett • Buffalo Grove • Elk Grove • Hanover Park • Hoffman Estates • Inverness • Mount Prospect  
Palatine • Prospect Heights • River Trails • Rolling Meadows • Salt Creek • Schaumburg • South Barrington • Streamwood • Wheeling

---

3000 West Central Road, Suite 205 • Rolling Meadows, IL 60008 • VOICE 847/392-2848 • FAX 392-2870 • TTY 392-2855 • [www.nwsra.org](http://www.nwsra.org)

**Section 1:**  
**FLOOR PLAN**

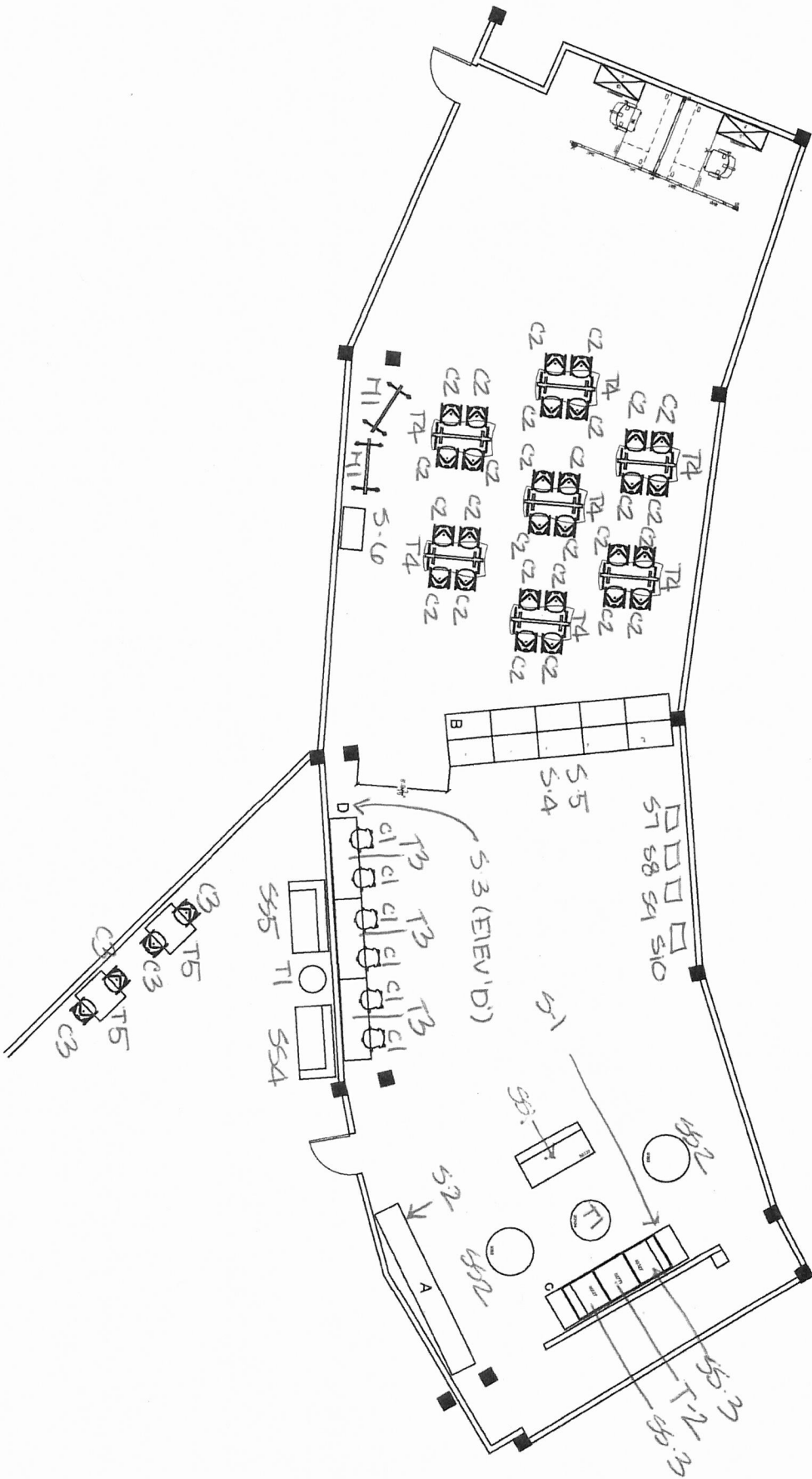





**Section 2:**



**NWSRA FURNITURE AND INSTALLATION  
PROPOSAL WORKSHEET**





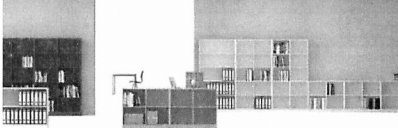

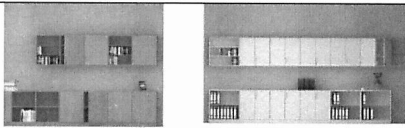
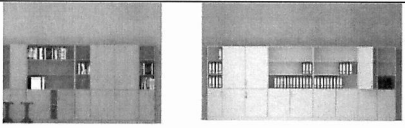
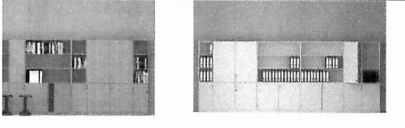
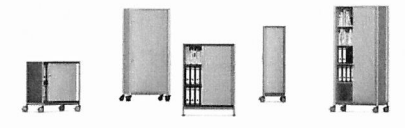
**NWSRA FURNITURE AND INSTALLATION PROPOSAL WORKSHEET**

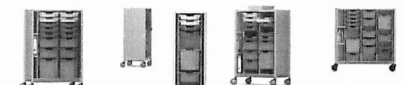

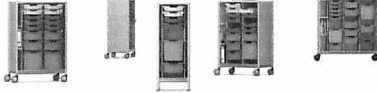
Quote proposal including purchase and installation of furniture as outlined in the NWSRA specifications for this project. Bidder may present alternative furniture that meets specifications outlined. If alternative but similar furniture is presented, bidder must provide images and specifications of proposed individual pieces.

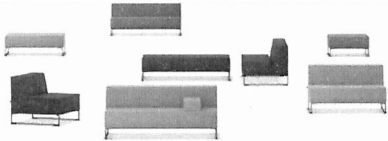
**Furniture**

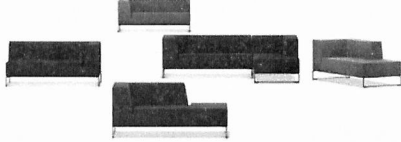
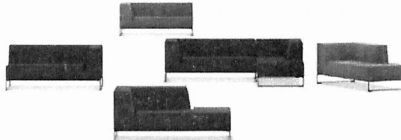
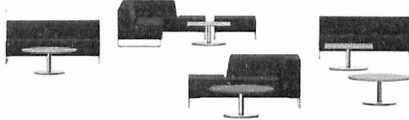
| Description  | Quantity | Image (for reference)  | Cost |
|--|----------|--|------|
| Product Description: Adjustable ht, 5 star base chair with casters and poly blow mold shell<br>Ht adj from 16.5"-21.5"<br>Finishes: Black Grey Seat with Arctic Base | 6        |    |      |
| Product Description: Cantilevered base with 2 component glides, poly blow mold shell 18" SH<br><br>Finishes: Arctic Frame and Black Grey Poly seat                   | 25       |    |      |
| Product Description: 30" SH 4 leg stool with blow mold poly shell<br>Finishes: Arctic frame and Black Grey seat  | 4        |  |      |
| Product Description: Movable marker board<br>39"W x 74"H<br><br>Finishes: Arctic Frame   | 2        |  |      |
| Product Description: Library Unit- 126"W x 92"H x 36"D (elevation 'C')<br>Fabric: Maple laminate with matching edge  | 1        |  |      |
| Product Description: Top Shelf with Locking Door, Bottom Open<br>Cubbies 39"W x 77.5"H x 23.5" D   | 4        |  |      |

|   |    |  |  |
|---|----|--|--|
| Finishes: Natural Maple Laminate with matching edge   |    |  |  |
| Product Description: Laminate wall cabinet with 2 locking doors and 2 adjustable shelves<br>31.5"W x 30"H x 14"D<br>Finishes: Natural Maple Laminate                                  | 3  |    |  |
| Product Description: Laminate tall cabinet with locking doors and 3 adjustable shelves<br>24"W x 63"H x 24"D<br>Finishes: Natural Maple Laminate                                      | 1  |    |  |
| Product Description: Laminate tall cabinet with 2 locking doors and 5 adjustable shelves<br>39"W x 92"H x 24"D<br>Finishes: Natural Maple Laminate                                    | 10 |    |  |
| Product Description: metal framed mobile storage with rolling shutter door locking 1 adjustable shelf<br>36"W x 35"H x 19"D<br><br>Finishes: Astral Laminate and Arctic Frame         | 1  |   |  |
| Product Description: Movable cabinets with 2 partitions (2 adjustable shelves in each of the 3 rows) 3 locking doors.<br>41.5"W x 43"H x 17"D<br><br>Finishes: Natural Maple Laminate | 1  |  |  |
| Product Description: Movable cabinets with 2 partitions (2 adjustable shelves in each of the 3 rows) open no doors.<br>41.5"W x 43"H x 17"D<br>Finishes: Natural Maple Laminate       | 1  |  |  |
| Product Description: Steel framed movable cabinet, 3 rows of trays to accommodate 6"H trays.<br>33.5"W x 49"H x 19"D  | 1  |  |  |

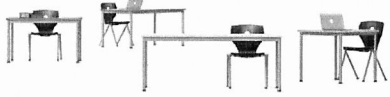
|   |    |  |  |
|---|----|--|--|
| Finishes: Astral Silver, Arctic Frame   |    |  |  |
| Tote Trays (9197)<br>12"W x 17"D x 6"H<br>Color: Blue   | 12 |    |  |
| Product Description: Steel framed movable cabinet, 2 doors, 1 fixed shelf and 2 adjustable shelves<br>33.5"W x 62.5"H x 19"D<br>Finishes: Astral Silver, Arctic Frame | 1  |    |  |
| Product Description: Upholstered sofa with metal legs, 63"wx31.5"D, 16" SH<br>Fabric: Manhattan MH41 Grey   | 1  |    |  |
| Product Description: Cloud Bean Bag 55"H x 41" Diam.<br>Fabric: S41 Cordura 3737 Bordeaux   | 2  |    |  |
| Product Description: Lounge Hi-Back Chair 31.5"W x 54"H x 31.5"D<br>Fabric: S45 Manhattan MH41 Grey   | 2  |   |  |
| Product Description: Upholstered right corner sofa with metal legs, 63"w x31.5"D, 16" SH<br>Fabric: Manhattan MH41 Grey   | 1  |  |  |
| Product Description: Upholstered left corner sofa with metal legs, 63"w x31.5"D, 16" SH<br>Fabric: Manhattan MH41 Grey  | 1  |  |  |
| Product Description: 35" Round disc base, laminate top<br>Fabric: Maple laminate with matching edge   | 1  |  |  |
| Product Description: Table with disc base 31.5" Sq. 27"H<br>Finishes: Natural Maple Laminate with matching edge and Arctic base                                       | 1  |  |  |

|  |          |  |  |
|--|----------|--|--|
| <p>Product Description: 4 leg steel frame table with laminate top<br/>         Finishes: Natural Maple Laminate with matching edge and Arctic Frame</p>                                | <p>3</p> |  |  |
| <p>Product Description: Flip table-<br/>         Curved laminate top with steel flip top base, 4 locking casters<br/><br/>         Finishes: Arctic Frame and Natural Laminate top</p> | <p>7</p> |  |  |
| <p>Product Description: Stand table with disc base 31.5" Sq. 40.5" H<br/>         Finishes: Natural Maple Laminate with matching edge and Arctic base</p>                              | <p>2</p> |  |  |
| <p><b>Total furniture cost including installation:</b></p>   |          |  |  |



**Work Station Area**

Specifications below based on:

1. Manufacturer: Hon
2. Product: Hon Accelerate Panels, Hon Ignition Seating, Hon Series 38000 Desking
3. Include all hardware, connectors, end covers, panel top caps, straight connectors required.
4. Include all labor to unload, unpackage, remove waste, and assemble.

Following is a rendering of the work station area:

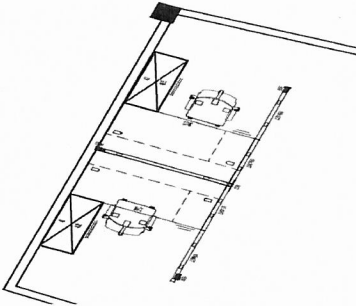

Bidder may present an alternative work station area that meets specifications outlined. If alternative but similar work station is presented, bidder must provide images and specifications of proposed individual pieces as well as images and specifications of proposed completed piece.

| Description   | Quantity | Cost |
|---|----------|------|
| HEWS6572FP Tackable Panel<br>65H x 72W Grade A fabric                             | 1        |      |
| HEWS65P Wall Starter 65H Core<br>Paint  | 1        |      |
| HIWM1 Ignition Mid-Back Task<br>Chair Grade 1 Fabric                              | 2        |      |
| H38293R 72 x 36 Single Pedestal<br>Desk with lock Core<br>Paint/Standard Laminate | 1        |      |
| H9190A Flagship Lateral File 2<br>Drawer 42W Core Paint                           | 2        |      |
| H38294L 72 x 36 Single Pedestal<br>Desk with lock Core<br>Paint/Standard Laminate | 1        |      |
| HETP6536FP Tackable Panel<br>65H x 36W Grade A Fabric                             | 2        |      |
| HETP6542FP Tackable Panel<br>65H x 42W Grade A Fabric                             | 2        |      |
| <b>Total work station cost including<br/>installation:</b>                        |          |      |

**Section 3:**  
**NWSRA FURNITURE AND INSTALLATION**  
**PROPOSAL FORM**



Section 4:

**NWSRA FURNITURE AND INSTALLATION  
TIMELINE AND ACKNOWLEDGEMENT**

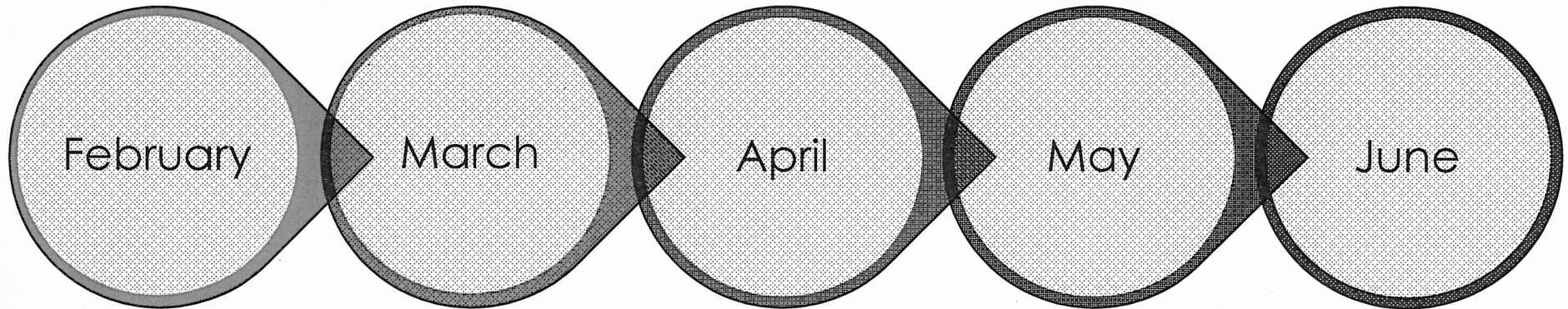

•Go to bid for furniture

•Furniture bid awarded at March 22<sup>nd</sup> NWSRA Board Meeting

•Week of March 27<sup>th</sup> furniture finishing's chosen and furniture ordered

•Installation of furniture

•Installation of furniture deadline May 31<sup>st</sup>

•Grand opening of NWSRA Programming Space at Hanover Park Community Center

# NWSRA FURNITURE AND INSTALLATION TIMELINE

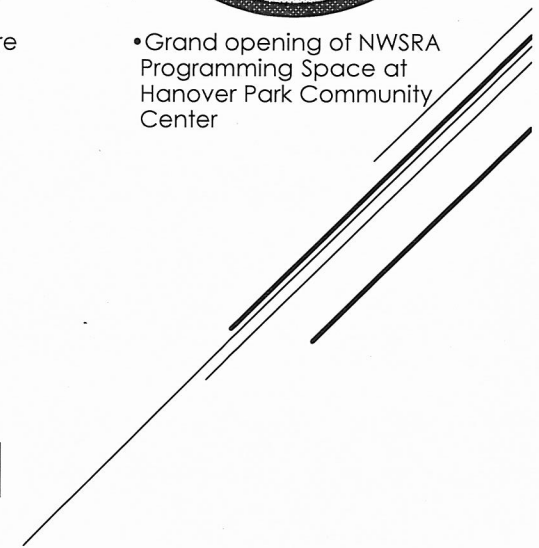

**NWSRA FURNITURE AND INSTALLATION TIMELINE ACKNOWLEDGEMENT**

The undersigned business declares that he/she has carefully examined the NWSRA Furniture and Installation Timeline and that he/she is thoroughly familiar therewith, and has made such investigations that are deemed necessary to ensure that stated timeline is met, and he/she agrees that should this proposal be accepted he/she will execute and enter into a contract with the Board of Trustees of the Northwest Special Recreation Association. He/she also accepts and acknowledges that if the business is unable to supply furniture according to the timeline, the business agrees to provide NWSRA with display boards at least 24" x 36" full color that contain images of furniture. Display boards must be received at NWSRA Park Central, 3000 W. Central Rd., Suite 205, Rolling Meadows, IL 60008 by May 1, 2017.

Comments related to Installation Timeline: \_\_\_\_\_

\_\_\_\_\_

\_\_\_\_\_

\_\_\_\_\_

\_\_\_\_\_  
Authorized By

\_\_\_\_\_  
Date

\_\_\_\_\_  
Phone

\_\_\_\_\_  
Company Name

\_\_\_\_\_  
Company Address